

Beverley and District Motor Club Limited
Maple Garage Beaver Rally
26th/27th November 2005

Route Handout 1

Turn left and proceed to NTC2 @ 193351

Rejoin Points

NTC9 @ N 2415029850

NTC26 @ 1315039075

NTC35 @ S 1660051300

Beverley and District Motor Club Limited
Maple Garage Beaver Rally
26th/27th November 2005

Route Handout 2

From NTC2 @ 193351 proceed via the following herringbone

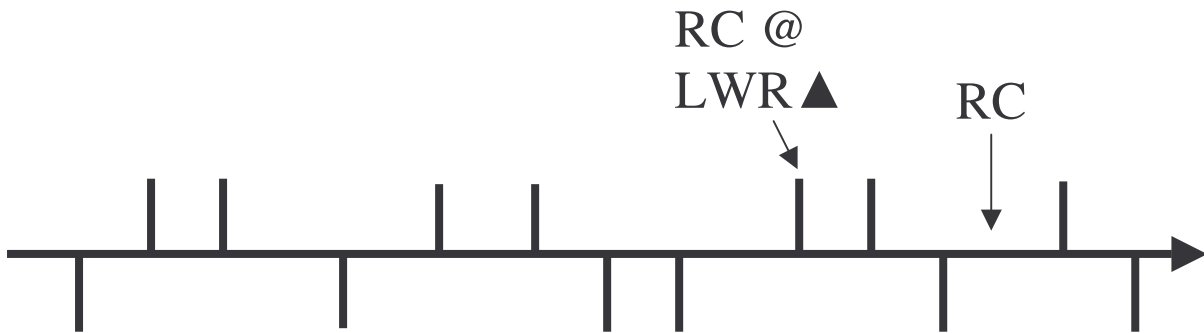

Via GW @ 240½386S to NTC5 on the B1242

Quiet Aldbrough

Beverley and District Motor Club Limited
 Maple Garage Beaver Rally
 26th/27th November 2005

Route Handout 3

From NTC5 @ 251¹/₄373 via the following in reverse alphabetical order.

X 2537	J 2733	O 2634 & 2735 Look	U 2535
R RC @ lwr ▲ 2 nd junction and SGW	E 2532	H 2733	D 2632 RC @ lwr ▲ 1 st junction
L 2733	T 2635	W 2536	K 2833
B 2432	V Route check	C 2532	F 2533
I 2732	G 2633	M Route check	P OK
N 2734	A 2431	S 30 mph	Q SGW

Approach 14 from the South West

Beverley and District Motor Club Limited
Maple Garage Beaver Rally
26th/27th November 2005

Route Handout 4

Proceed to NTC9 @ 2415029850 via the following

242½314½ GW

247½313½ DEPART - S

Hand in time card 1 and ensure the marshal carries forward your time onto card 2. There is no need for the marshal to sign time Card 2

Quiet in Burton Pidsea.

Beverley and District Motor Club Limited
Maple Garage Beaver Rally
26th/27th November 2005

Route Handout 5

Proceed from NTC9 @ 241½/298¼ via the following



STC10 will be found on the correct route. NTC11 is at
2975027775

Beverley and District Motor Club Limited
Maple Garage Beaver Rally
26th/27th November 2005

Route Handout 6

Route check see NAM

24

24

17

12

SGW

RC @ LWR ▲ at junction before next instruction

27

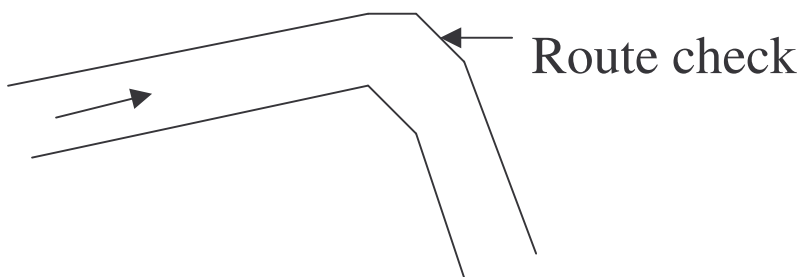

Via 298¹/₂240³/₄GW to NTC14 @ 246246¹/₂
Quiet Keyingham.

You have plenty of time.

Beverley and District Motor Club Limited
Maple Garage Beaver Rally
26th/27th November 2005

Route Handout 7

From NTC14 @ 246246½ via the following information.
This is a regularity section.

24routecheckcaution24routecheck242423routecheck2322
routecheckCARE23routecheck242121routecheck2521

Then proceed via the following

207¼259¾ GW

208264¾ GW

Quiet Thorngumbald

Spot height 3

B1240

189285

189287½

190½288 GW







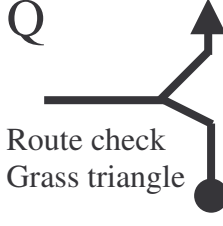

Quiet Hedon

To RTC16 @198290

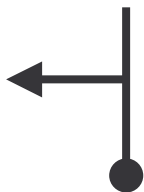
Beverley and District Motor Club Limited
 Maple Garage Beaver Rally
 26th/27th November 2005

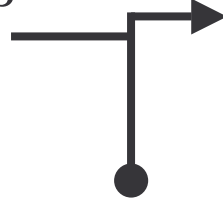
Route Handout 8

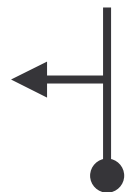
From RTC16 @ 198290 via the following in alphabetical order. Coloured roads only.

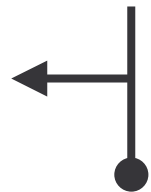
<p>A</p> <p style="text-align: center;">RC</p>	<p>B</p> 	<p>C</p> <p style="text-align: center;">RC</p>	<p>H</p> <p style="text-align: center;">RC</p>
<p>I</p> <p style="text-align: center;">30 MPH</p>	<p>M</p> <p style="text-align: center;">RC</p>	<p>Q</p>  <p style="font-size: small;">Route check Grass triangle</p>	<p>K</p>  <p style="text-align: center;">SGW</p>
<p>P</p>  <p style="text-align: center;">SGW</p>	<p>D</p> 	<p>T</p>  <p style="text-align: center;">SGW</p>	<p>F</p> 
<p>S</p> 	<p>L</p> <p style="text-align: center;">END 30 MPH</p>	<p>E</p> <p style="text-align: center;">STC</p>	<p>R</p> <p style="font-size: small;">Not as Map route Checks x 2</p> 
<p>G</p> 	<p>N</p>  <p style="text-align: center;">SGW</p>	<p>O</p> <p style="text-align: center;">STC</p>	<p>J</p> 

Proceed to petrol at 203350 via B road and hand in time card 2. Restart at MTC20 @ 188350 on your scheduled time.

Beverley and District Motor Club Limited
Maple Garage Beaver Rally
26th/27th November 2005

Route Handout 9

This is a regularity section.

The section to the intermediate control should be driven at 27.6 miles per hour. There are 3 route checks on the section. You cannot stop within sight of the intermediate control without penalty.

The time to the regularity control which is at 1405036100 approach WSW is 8 minutes. You may wait at this control for your time without penalty.

Black square 1535 NW $\frac{1}{2}$

GW in square 1535 and 1435

Beverley and District Motor Club Limited
Maple Garage Beaver Rally
26th/27th November 2005

Route Handout 10

All roads shown from RTC22 @ 1405036100

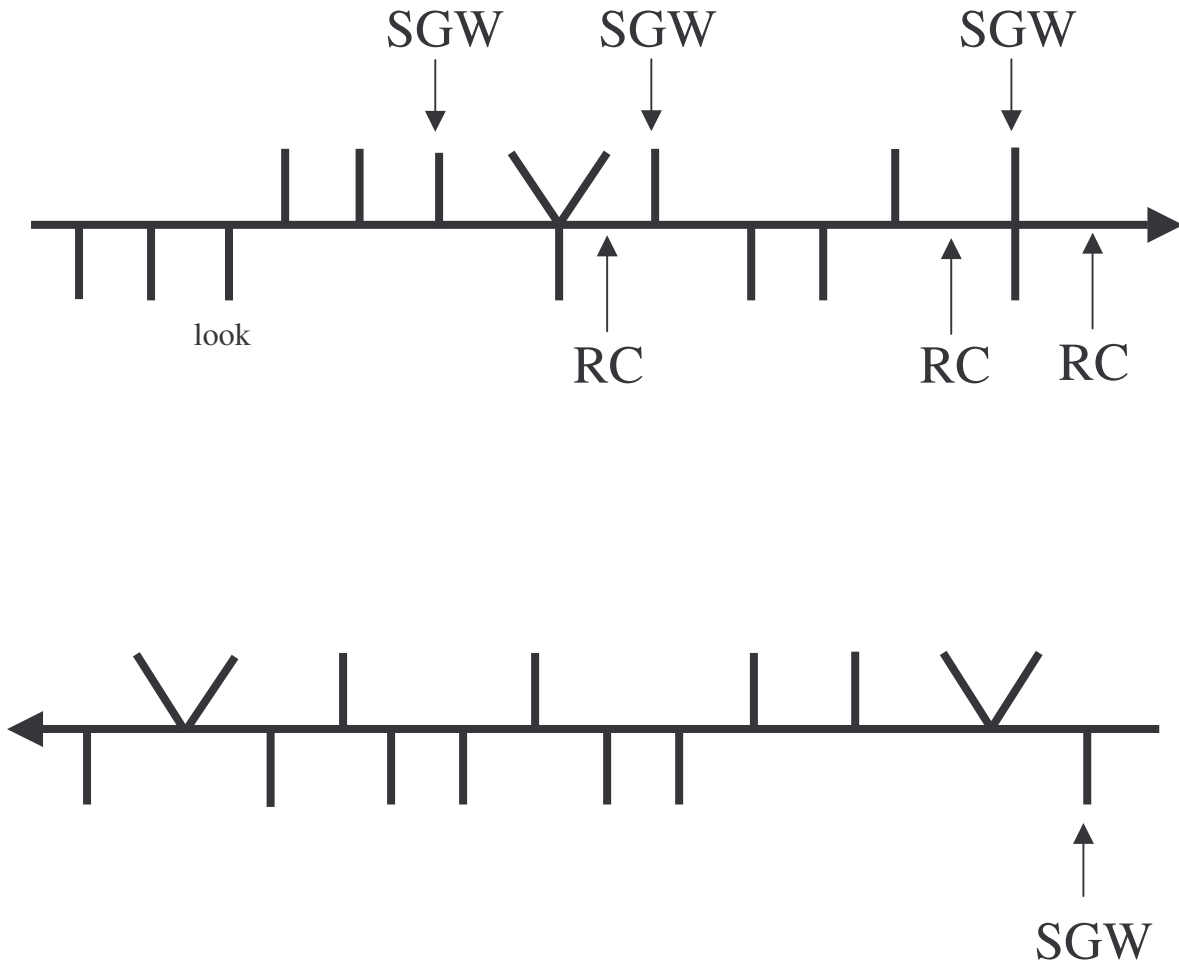

QUIET - Old and New Ellerby

NTC 24 @ 1665040200

Beverley and District Motor Club Limited
Maple Garage Beaver Rally
26th/27th November 2005

Route Handout 11

From NTC24 @ 1665040200







1
2
3
4
5
6
7
8
9
10
11
12
13
14
15
16
17
18
19
20
21
22
23
24
25
26
27
28
29
30
31
32
33
34
35
36
37
38
39
40
41
42
43
44
45
46
47
48
49
50
51
52
53
54
55
56
57
58
59
60
61
62
63
64
65
66
67
68
69
70
71
72
73
74
75
76
77
78
79
80
81
82
83
84
85
86
87
88
89
90
91
92
93
94
95
96
97
98
99
100

Quiet Skirlough. Black square 1339 northern half

Beverley and District Motor Club Limited
 Maple Garage Beaver Rally
 26th/27th November 2005

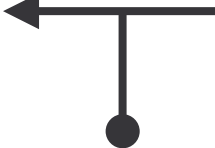
Route Handout 12

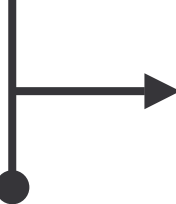
From NTC26 @ 1315039075. This is a regularity section. You may wait for your times at the intermediate control and the regularity control. The regularity control is located at 0970045450. Proceed in increasing numerical order.

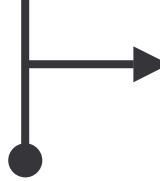
4 Route check	16 3	6 Stop and Give Way 0939	9 Route check
12 	8 	1 Stop and Give Way	11 6
2 	15 Route check	13 	5 
7 or	10 	3 	14 Route check

Give way at 'A' road and proceed via give way at the 1st left at the roundabout. Care 30 mph in Leven.

Beverley and District Motor Club Limited
Maple Garage Beaver Rally
26th/27th November 2005

Route Handout 13

From 0970045450 proceed via the following.

094509460947routecheck0948SGW0947routecheck1047

Black square 1047 southern half.

Quiet through Brandesburton to reach NTC30 at 113493
on the yellow road heading north from the village.

Fuel is available at 120½453. Take the A165 at 121½476
to 119454. Follow the reverse when returning to NTC30

Beverley and District Motor Club Limited
 Maple Garage Beaver Rally
 26th/27th November 2005

Route Handout 14

From NTC30 @ 1130049300 proceed via the following herringbones.

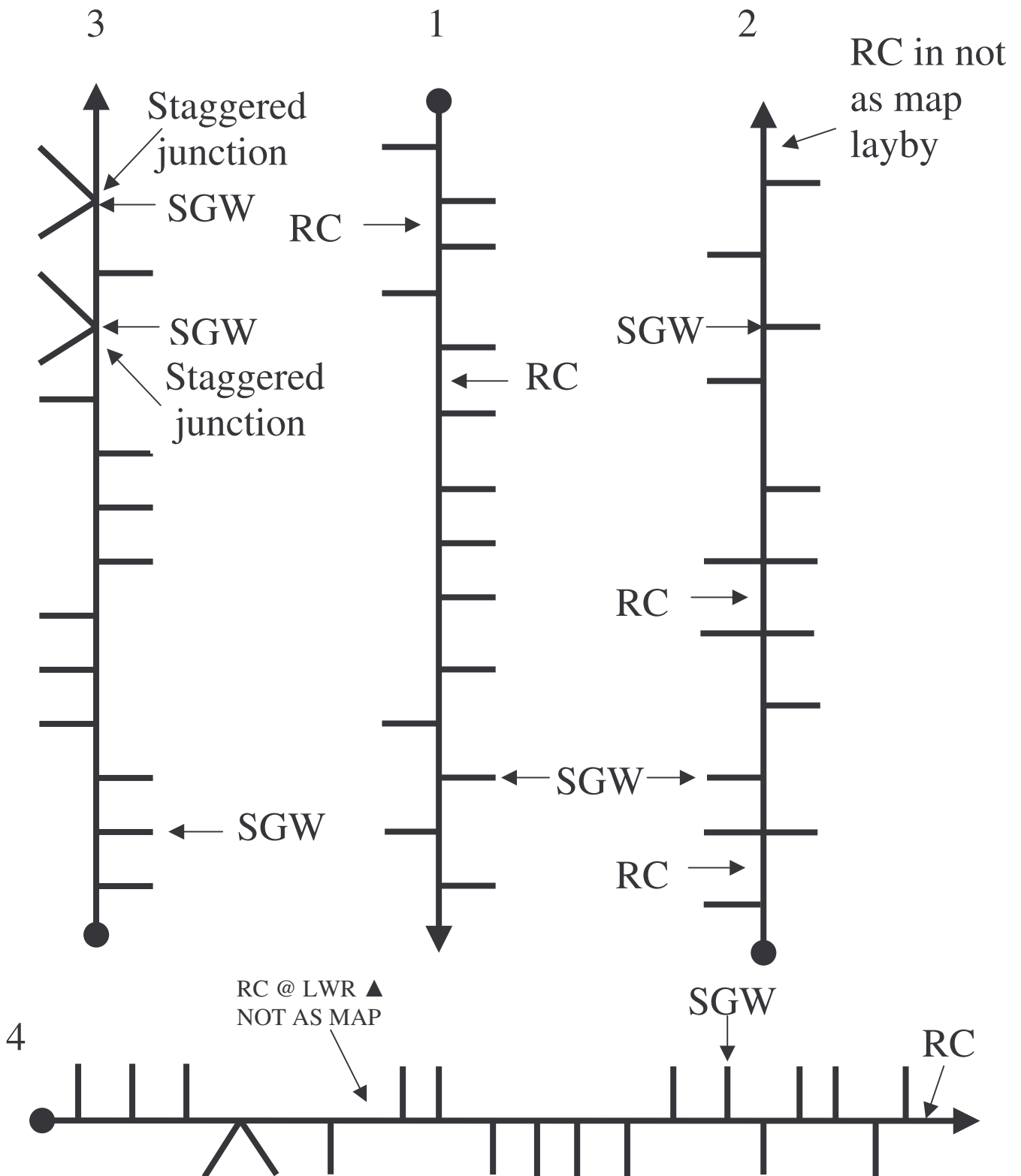

Hand in time card 3 at NTC35 and ensure the marshal carries forward your time onto card 4. There is no need for the marshal to sign time card 4

Beverley and District Motor Club Limited
Maple Garage Beaver Rally
26th/27th November 2005

Route Handout 15

NTC35 is at 1660051300. This is a regularity section.
You may wait for your times at the intermediate control
and the regularity control. The regularity control is
located at 1155054250. Quiet in Beeford.

Black spot 1620054200 100m

Black Square 1352 Southern half

NRCNNWSRCSWRCWNNWW

Beverley and District Motor Club Limited
Maple Garage Beaver Rally
26th/27th November 2005

Route Handout 16

From RTC37 at 1155054250 proceed by the following to
NTC41

8 5 16 14 12 8 7 12 16 RC @ LWR ▲ then RC @ LWR
▲ 12 38 18 RC 24 73

Quiet Lowthorpe.

NTC41 is at 0770064650

GW in squares 0761 and 0762

Beverley and District Motor Club Limited
 Maple Garage Beaver Rally
 26th/27th November 2005

Route Handout 17

Via the following reverse numerical order from NTC41
 which is at 0770064650

25 0864	24 0865	23 73	22 0965	14 0965
3 route check	7 1266	20 0963	16 47	9 1166
18 1063	10 route check	17 1064	12 75	2 1365
4 1366	6 79	21 0964	13 1065	5 75
1 1465	11 1066	19 RC @ LWR ▲	15 1065	8 82

Beverley and District Motor Club Limited
Maple Garage Beaver Rally
26th/27th November 2005

Route Handout 18

Proceed via the following to MTC44 at 177539½
approach NNW.

146½655 GW

LC in square 1464

Roundabout in 1564 GW depart SW

To map 107

Take the B1242 just before Lissett

Quiet West End

Quiet Skipsea

On arrival at the finish venue, park your car at the rear of the premises; you can use the grass if needed. Proceed to the entrance up a flight of stairs located down the drive as you entered the venue. Follow the signs. As this is a residential hotel, please be extremely quiet and do not slam doors or rev your engines.

Complete your damage declaration form and hand this in with time card 4 to the control that will be as you enter the venue. Provisional results from the previous time cards will be available.

Enjoy your breakfast and wait for the results to be produced.